

 **Berchmans**
INSTITUTE OF MANAGEMENT STUDIES
St. Berchmans College Autonomous

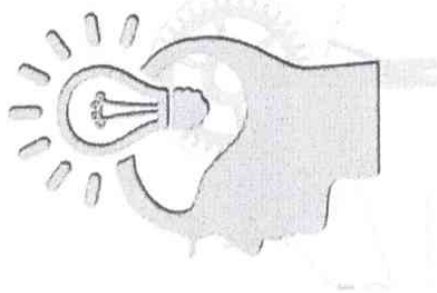

ENTREPRENEURSHIP AWARENESS PROGRAMME

JANUARY 11, 2019

In Association with

District Industries Centre, Kottayam
Directorate of Industries and Commerce
Government of Kerala



EN

Entrepreneurship Awareness Programme for College students - January 11, 2019



3 DAY INTERNATIONAL SEMINAR

TOPIC- International Trade –Trade War- Shared Prosperity

IPR



**INTERNATIONAL SEMINAR ON
INTERNATIONAL TRADE
TRADE WAR
SHARED PROSPERITY**
(10-12 DECEMBER 2018)

RESEARCH & POSTGRADUATE DEPARTMENT
OF COMMERCE

ST BERTHMAN'S COLLEGE
CHANGANNUR

IN ASSOCIATION WITH
INDIAN ACCOUNTING ASSOCIATION &

SRINIVASA GANDHI UNIVERSITY
MOTTIVAKKI

VYALE ARCHBISHOP CARDINAL PADYARA HALL



**THREE DAY
INTERNATIONAL SEMINAR ON
INTERNATIONAL TRADE
TRADE WAR
SHARED PROSPERITY**
(10-12 DECEMBER 2018)

VENUE: VYALE ARCHBISHOP CARDINAL PADYARA HALL

PROGRAMME & SPEAKERS

DAY 1: 10 DECEMBER 2018

10:00 AM - Registration & Inauguration
11:00 AM - Session 1: International Trade & Trade Wars
12:30 PM - Lunch
2:00 PM - Session 2: Trade Wars & Shared Prosperity
4:00 PM - Session 3: Globalization & Trade Wars
6:00 PM - Dinner

DAY 2: 11 DECEMBER 2018

10:00 AM - Session 4: Trade Wars & Shared Prosperity
12:30 PM - Lunch
2:00 PM - Session 5: Trade Wars & Shared Prosperity
4:00 PM - Session 6: Trade Wars & Shared Prosperity
6:00 PM - Dinner

DAY 3: 12 DECEMBER 2018

10:00 AM - Session 7: Trade Wars & Shared Prosperity
12:30 PM - Lunch
2:00 PM - Session 8: Trade Wars & Shared Prosperity
4:00 PM - Session 9: Trade Wars & Shared Prosperity
6:00 PM - Dinner



**THREE DAY
INTERNATIONAL SEMINAR ON
INTERNATIONAL TRADE -
TRADE WAR -
SHARED PROSPERITY
(10-12 DECEMBER 2018)**

ORGANISED BY
**RESEARCH & POSTGRADUATE DEPARTMENT
OF COMMERCE**



**ST BERCHMANS COLLEGE
CHANGANACHERRY**

IN ASSOCIATION WITH
INDIAN ACCOUNTING ASSOCIATION &



**MAHATMA GANDHI UNIVERSITY
KOTTAYAM**

VENUE: ARCHBISHOP CARDINAL PADIVARA HALL

NCs

Transfer Pricing,

under

CDS,

rice

audit for

Mr Mark Camp is an executive director of International Tax & Transfer Pricing at Ernst & Young Global Delivery Services (GDS). At GDS he leads more than 250 transfer pricing & international tax compliance GDS professionals in India & China. He did his BS & MS in Economics from Texas A & M University, USA.



Dr K J Joseph who currently holds the position of Minister of Commerce Chair Professor at the Centre for Development Studies, Thiruvananthapuram, is an alumnus of St. Berchmans College. He did his Ph D in Economics, at Jawaharlal Nehru University New Delhi. He is also the president of GLOBELICS. He has worked as a consultant to UNESCAP and UNCTAD.

Dr Sumati Varma is an Associate Professor at the Department of Commerce at Sri Aurobindo College (Evening), Delhi University. She received the prestigious International Visitor Leadership Programme (IVLP) fellowship in 2011, awarded by the US department of state for her contribution to the first ever programme on American Studies for Indian Universities. Dr Varma has been a consultant to several Indian and international organizations, including the World Bank Group and NCERT.



Dr Soumyatamu Mukherjee is presently an Assistant Professor in the India Institute of Management Kozhikode. He has completed his Ph D in International Economics from the University of Nottingham (UK) and has been the recipient of the prestigious Vice-Chancellor's Research Excellence Award (International) from the University of Nottingham. He is an external fellow of CREDIT & GDP, University of Nottingham. He has also recently been offered an Honorary External Research Fellow position at the Ural Federal University, Russia.



Administrative Block, Changanassery, Kerala 686 101, India
Changanassery
Kerala
India
2016-12-10 (Tue) 10:32(AM) 27°C
81°F



P.P. Joseph, Changanassery, Kerala 686 101, India
Changanassery
Kerala
India
2016-12-10 (Tue) 10:32(AM) 27°C
81°F



Administrative Block, Changanassery, Kerala 686 101, India
Changanassery
Kerala
India
2016-12-10 (Tue) 11:04(AM) 27°C
81°F



Trade College Rd, Changanassery, Kerala 686 101, India
Changanassery
Kerala
India
2016-12-10 (Mon) 02:56(PM) 29°C
84°F



NATIONAL WORKSHOP

Relativistic Quantum Mechanics

13-14 October at Department of Physics

Resource Persons:

Dr. S Sivakumar, Chennai Mathematical Institute

Dr. A Basherrudin Mahmud, Madurai Kamaraj University

Organised by

ACADEMY OF
PHYSICS
TEACHERS KERALA

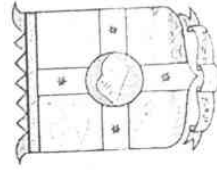

St Berchmans College

AUTONOMOUS

CHANGANACHERRY, KOTTAYAM, KERALA - 686 101



Resource Persons

1. DR S. SIVAKUMAR

Present Position : Adjunct Professor
Chennai Mathematical Institute, Chennai

Former Position : Scientist – G
Indira Gandhi Centre for Atomic Research
Kalpakkam 603 102

2. A. BASHERRUDIN MAHMUD AHMED

Assistant Professor Department of Theoretical Physics,
Madurai Kamaraj University

Dr Shajo Sebastian, Head Dept of Physics, SB College

Dr Issac Paul, Joint Secretary, APT

Dr G Harikrishnan , Coordinator, APT National Workshops (Govt College Madappally)

The Department of Physics SB College Changanaserry in collaboration with Academy of Physics Teachers Kerala organized a Two day National workshop for the Physics faculty of university and college on Relativistic Quantum Mechanics during 13 – 14 October 2018. A total of 28 teachers participated in the Two day workshop. Four students (final year UG) also participated in the workshop. The workshop was led by Dr S Sivakumar , Professor CMI, Chennai and the tutorials were handled by Dr Basherrudhin M. Ahmed of MKU, Madurai.

Sir/Madam

Department of Physics, St Berchmans College, Changanassery is organizing a National Workshop in association with Academy of Physics Scholars, Kerala.

Topic: RELATIVISTIC QUANTUM MECHANICS

Dates : 13-14 October 2018

Venue : Department of Physics

St. Berchmans College, Changanassery

**Resource persons : Dr. S Sivakumar, Chennai Mathematical Institute
Dr. A Babetherudhin Mahmud, Madurai Kamaraj University**

Start date for Registration : 25 September 2018

Registration fee :

For APT Life-members : Non-Resident : Rs.1100, Resident : Rs.1400.

For nonmembers there will be Rs.300 extra in both categories.

How to apply : Transfer the registration fee to the account of Shaju K Y, A/C No. 33518390497, SBI, Irinjalakuda, IFSC code : SBIN0008618 internet banking. Those who use core-banking should add Rs.57 extra inter-city core banking charge debited by the bank. After transferring fee, notify your name, college, amount credited, date of transaction and transaction ID by e-mail to ghkphysics@gmail.com.

Shaju Sebastian
Head of the Department

Prof Ajai Jose
Coordinator
Ph : 9446212921
E-mail : ajajoscsbe@gmail.com

Outline of the Lectures

Lecture 1

Review of special relativity, relativistic notation, concept of covariance, introduction to Klein-Gordon equation (KGE)

Lecture 2

Properties of KGE and its solutions, application to a particle in a potential limitations of KGE

Lecture 3

Dirac equation, algebra of γ matrices

Lecture 4

Emergence of spin and spin magnetic moment

(Tutorials will have problems related to or extending the topics being covered in the lectures)

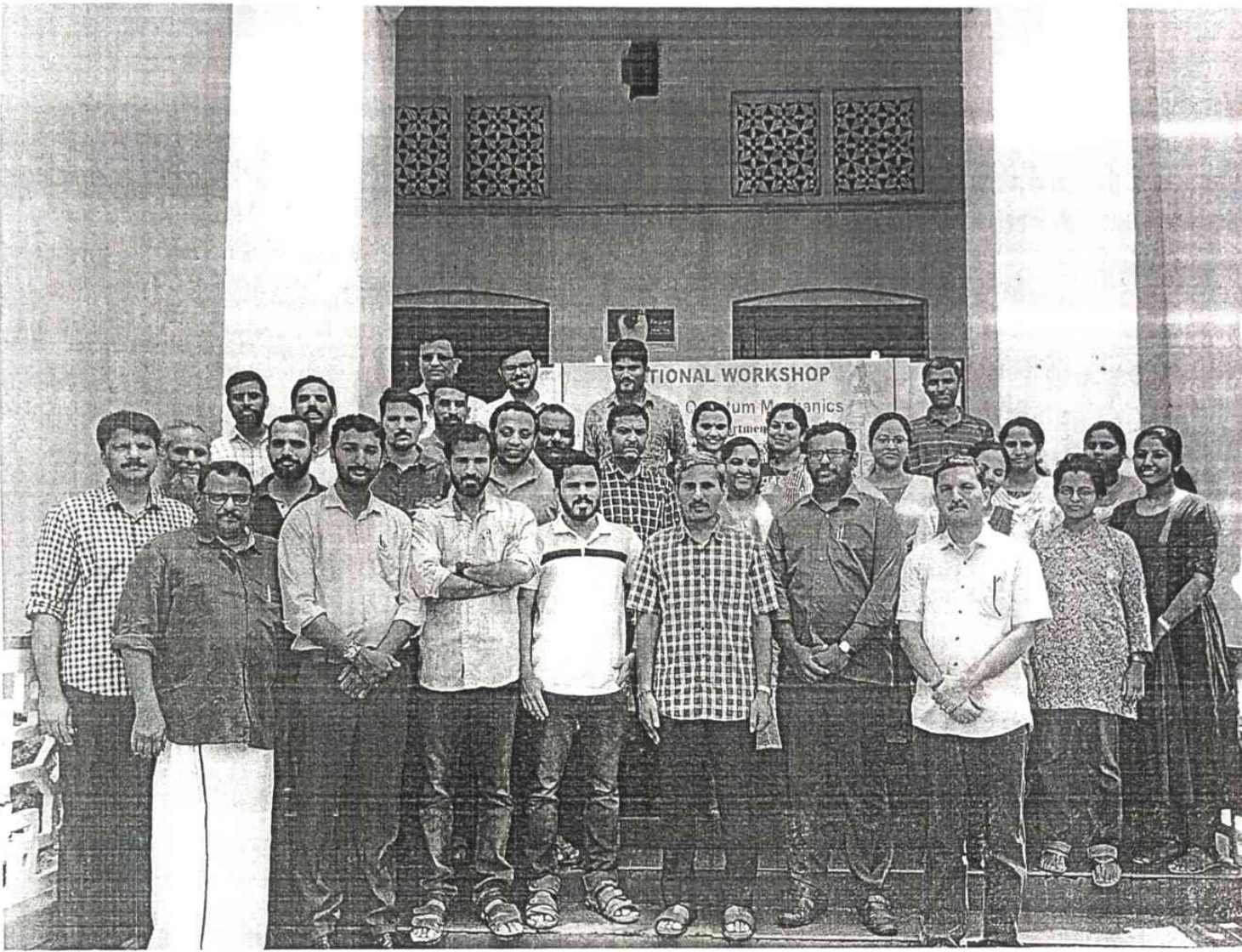

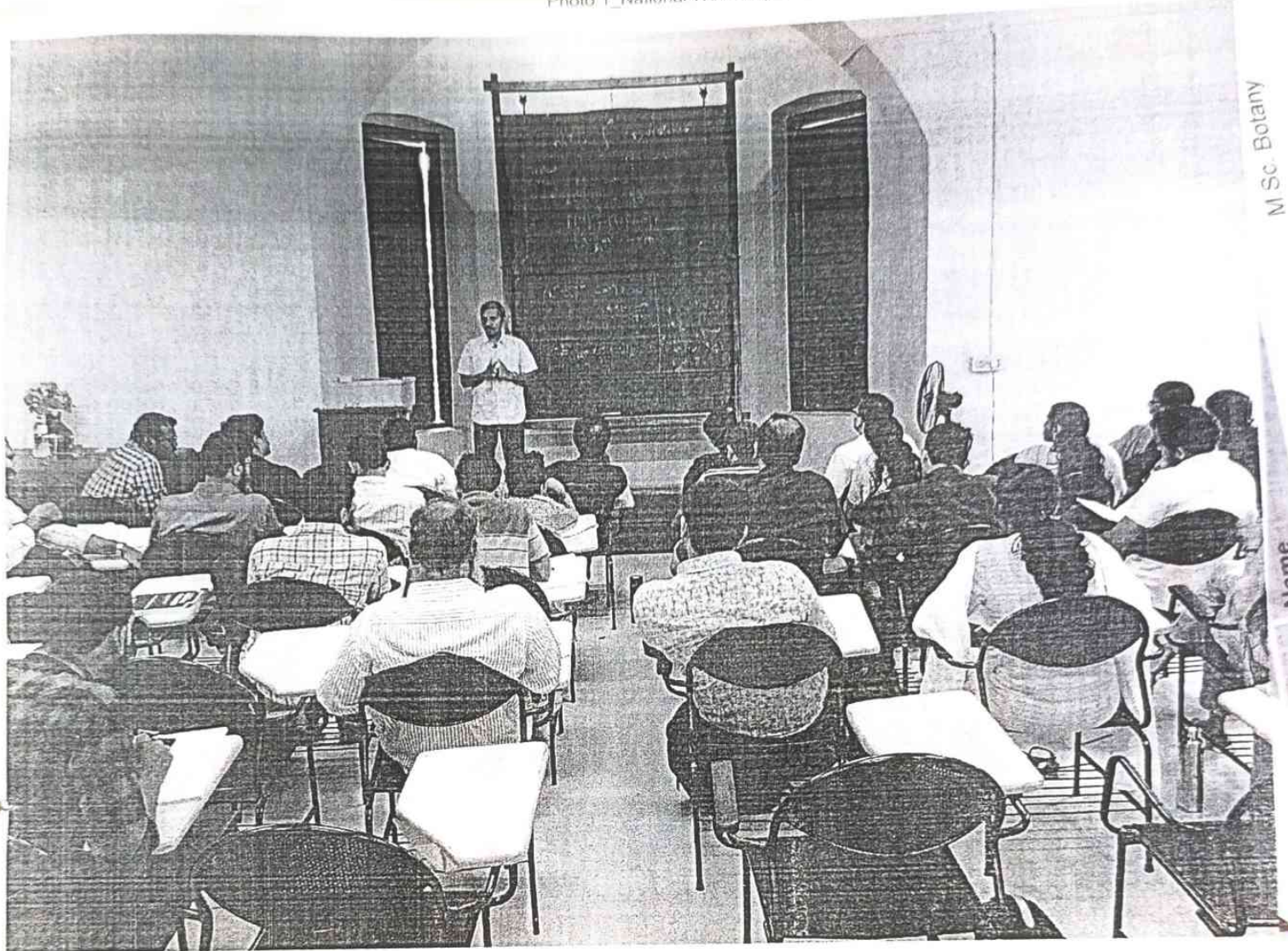





M. Sc. Botany

Name

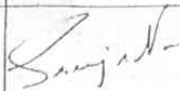
APT Workshop 9 | Series 4 | Quantum Mechanics Series]
13-14 October 2018 | SB College, Changanassery

KOTTAYAM (10)					
16.	Lyjo K. Joseph	Govt. College Kottayam	paid	<i>[Signature]</i>	
17.	Shajo Sebastian	SB college, Changanassery	1100 ✓	<i>[Signature]</i>	Paid.
18.	Issac Paul	SB college, Changanassery	1100 ✓	<i>[Signature]</i>	Paid
(19)	Sijo Sebastian	SB college, Changanassery	1400 ✓	<i>[Signature]</i>	Paid.
20.	Ajai Jose	SB college, Changanassery	N.A	<i>[Signature]</i>	
21.	Neha P R	Baselius College	paid	<i>[Signature]</i>	
ALAPUZHA (3)					
22.	Rose Leena Thomas	St. Joseph's College for Women	paid	<i>[Signature]</i>	
23.	Lakshmi Vijayan	St. Aloysius College, Edathua	paid	<i>[Signature]</i>	
24.	Rani George	St. Aloysius College, Edathua	paid	<i>[Signature]</i>	
KOLLAM (5)					
25.	Mohammed Salim M	TKM College of Arts and Science	paid	<i>[Signature]</i>	
26.	Renjith R	TKM College of Arts and Science	paid	<i>[Signature]</i>	
27.	Manoj. P.K	TKM College of Arts and Science	paid		
28.	Apama. L. R	TKM College of Arts and Science	paid		
29.	Safir TK	TKM College of Arts and Science	paid	<i>[Signature]</i>	
THIRUVANANTHAPURAM (1)					
30.	Abhilash Kumar R G	Government College for Women, TVM	1100 ✓	<i>[Signature]</i>	Paid.
TAMIL NADU (1)					
31.	Ravishankar C S	Chennai	paid	<i>[Signature]</i>	
32.	Rajan K-John	K. G College, Pampady 9447419806	1400 Paid ✓	<i>[Signature]</i>	Paid
33	Lishudha P. Mathew	K. G College, Pampady 9447414718	1100 paid	<i>[Signature]</i>	Paid

STUDENT SPOT REGISTRATION				
	Name	College	Amount	Sign
1. 28.	SREERAJ R NAIR	ST. BERTHMANS COLLEGE, CHANGANASSERY	N.A	
2. 34.	EMY MONS	BCM COLLEGE, KOTTAYAM	N.A	
3. 35.	Sanjay Sabu	SB College Changanassery	N.A	
4. 36.	Sasathi Leninshankar	S.B - College Changanassery	N.A	
37.				
38.				
39.				
40.				

Non Resident	APT Member	Rs 1100/=
	Others	Rs 1400/=
Resident	APT Member	Rs 1400/=
	Others	Rs 1700/=

SD

TWO DAY LECTURE SERIES ON FOUNDATIONS OF MATHEMATICS

AS PART OF THE

**NATIONAL MATHEMATICS DAY CELEBRATIONS ORGANIZED IN
ASSOCIATION WITH KSCSTE**

JULY 31 - AUGUST 1, 2018

TOTAL PARTICIPANTS:82

As part of National Mathematics Day, the Department of Mathematics organized Two day Lecture series in Foundations of Mathematics for undergraduate and post graduate students of the college and nearby colleges in association with Kerala State Council for Science, Technology and Environment (KSCSTE). The programme was held on July 31 st and August 1 st 2018. The Seminar was inaugurated by Dr Subrahmanian Moosath K S (Professor and Head, Department of Mathematics, IIST Thiruvananthapura). Dr Reji T (Government College Chittur, Palakkad), Dr V B Kiran Kumar (CUSAT, Kochi), Dr Manilal K (University College, Thiruvananthapuram) and Mr Rahul Rajan (Research Scholar, CUSAT, Kochi) were the resource persons for the seminar. The number of participants was 82, which included students from Pondicherry University, St Dominic's College Kanjirapally, BCM College, Kottayam, CMS College, Kottayam, T K M College of Arts and Sciences Kollam, St Thomas College, Thrissur and Assumption College Changanacherry. The coordinator of the programme was Ms Jinu Mary Jameson.

ESTABLISHED 1928
**DEPARTMENT OF
MATHEMATICS**

E-mail: maths@sbccollege.ac.in



ST BERCHMANS COLLEGE
(Autonomous) Founded 1922

College with Potential for Excellence.
Reaccredited by NAAC with A Grade

Affiliated to
Mahatma Gandhi University, Kottayam, Kerala



TWO DAY LECTURE SERIES IN FOUNDATIONS OF MATHEMATICS

Sponsored By

KERALA STATE COUNCIL FOR SCIENCE, TECHNOLOGY AND ENVIRONMENT (KSCSTE)

Supported By

DEPARTMENT OF SCIENCE & TECHNOLOGY (DST), GOVT. OF INDIA

INVITATION

Dear Sir/Madam,

- As part of the National Mathematics Day celebrations the Department of Mathematics, in association with KSCSTE Thiruvananthapuram and DST Government of India, is organizing a two day *Lecture series in Foundations of Mathematics* for UG and PG Mathematics students on 30th and 31st July 2018. Kindly send five selected students from your Department for the programme.

With best regards

Rev Fr John Joseph

Principal



Dr Antony Mathews

HoD and Coordinator

SPEAKERS

Dr M N Narayanan Namboodhiri, Formerly Professor of Mathematics, CUSAT, Kochi.

Dr Subrahmanian Moosath K S, Professor and Head, Department of Mathematics, IIST Thiruvananthapuram.

Dr Reji T, Associate Professor, Department of Mathematics, Government College Chittur, Palakkad.

- Dr V B Kiran Kumar, Assistant Professor, Department of Mathematics CUSAT, Kochi.

Dr Manilal K, Assistant Professor, Department of Mathematics, University College, Thiruvananthapuram.

For more details, contact Ms Treasa Maria Kuriakose (Secretary), Department of Mathematics.
Phone: 8281446459 Email: maths@sbccollege.ac.in



Kerala State Council for Science, Technology and Environment

Dr. Anilkumar C
Principal Scientist and Head
Science Education Division

13-07-2018

No. C-64/NMD/2017/KSCSTE

Sir Madam,

Sub: - KSCSTE – National Mathematics Day 2017- Celebrations – reg.
Ref: - File No. KSCSTE/146/2018 – NMD

With reference to your proposal, I am happy to inform that KSCSTE has approved to offer financial assistance of ₹10000/- for organizing the National Mathematics Day (NMD) 2017 celebrations, subject to the following conditions.

1. Programme schedule should be sent to KSCSTE well in advance.
2. Eminent speakers/ experts may be invited to handle the sessions organized in connection with the programme.
3. Though December 22 is observed as National Mathematics Day, the activities in your institution may be organized on any convenient date between July 15 and August 15, 2018. The activities organized after August 15, 2018 will not be considered for financial assistance.
4. Each activity should be documented. Detailed report on the various activities organized in connection with NMD - 2017 along with captioned photographs should be submitted to KSCSTE.
5. KSCSTE should be duly acknowledged in the programme and it should be written in all the brochures, banners, publicity materials, etc. 'Sponsored by Kerala State Council for Science, Technology and Environment' and supported by 'Department of Science & Technology, Govt. of India'.
6. The financial assistance may be utilized to cover the expenditure on organizing expenses, publicity materials, travel expenses, honoraria for resource persons and refreshment. Utilization of the grant for any other purpose other than the approved heads shall not be entertained.
7. On successful completion of the programme, the Head of the Institution should forward the following documents to The Director, KSCSTE - **Final report on the organized programme including necessary photographs, official bank account details of Head of the Institution, audited Statement of Expenditure and Utilization Certificate in the standard format available in the KSCSTE website. Also send soft copy for all**
8. The financial assistance will be disbursed to the Head of the Institution, only after the successful conduct of the programme, subject to the submission of satisfactory report and financial statements.
9. The required documents mentioned above should reach this office as early as possible after the conduct of the programme. However, the documents received after August 30, 2018 will not be entertained for release of payment and such request will be summarily rejected.

Kindly refer the Letter No and File No. in all future correspondence.

Name of the Programme Co-ordinator: Dr. Antony Mathews

Thanking you,

Yours sincerely

Anilkumar C

To,
The Principal, St. Berchmans College, Changanassery, Kottayam, Kerala-686101
Dr. Antony Mathews, Associate Professor & Head, Mathematics, St. Berchmans College, Changanassery,
Kottayam, Kerala-686101.





TWO DAY IMRT WORKSHOP ON FOUNDATIONS OF COMPLEX ANALYSIS

**ORGANIZED IN ASSOCIATION WITH INSTITUTE OF
MATHEMATICS RESEARCH AND TRAINING (IMRT)**

15-16 DECEMBER 2018

TOTAL PARTICIPANTS:106

In order to impart basic knowledge in Complex Analysis, the Department in association with Institute of Mathematics Research and Training (IMRT), Thiruvananthapuram, organized a two day workshop on Foundations of Complex Analysis for the post graduate students of our college and nearby colleges on 15 th and 16 th December 2018. Dr A R Rajan (Director, IMRT and formerly, University of Kerala), Dr Manilal K (University College, Thiruvananthapuram) and Mr Preenu C S (University College, Thiruvananthapuram) were the resource persons of the workshop. The number of participants was 106. The coordinator of the workshop was Dr Shine C Mathew

Registration

The number of outside students is limited to 40. The selection will be on 'First Come First Served' basis.

Those who wish to attend the Workshop must register through e-mail.

The selected participants will be intimated through e-mail.

Participants must bring an authorization letter from the authorities concerned.

Registration fee: Rs.100 per participant.

Lunch, Tea and Snacks will be provided.

Organizing Committee

Antony Mathews

Fr John J Chavara

Chair

Shine C Mathew

Coordinator

Prof M C Jose

Tibin Thomas

Ullas Thomas

Treasa Maria Kuriakose

Jinu Mary Jameson

James T Kurian

Jaison Jose

Contact Us

Mobile: +91 9847531272

mail: maths@sbccollege.ac.in

COMPT WORKSHOP 2018

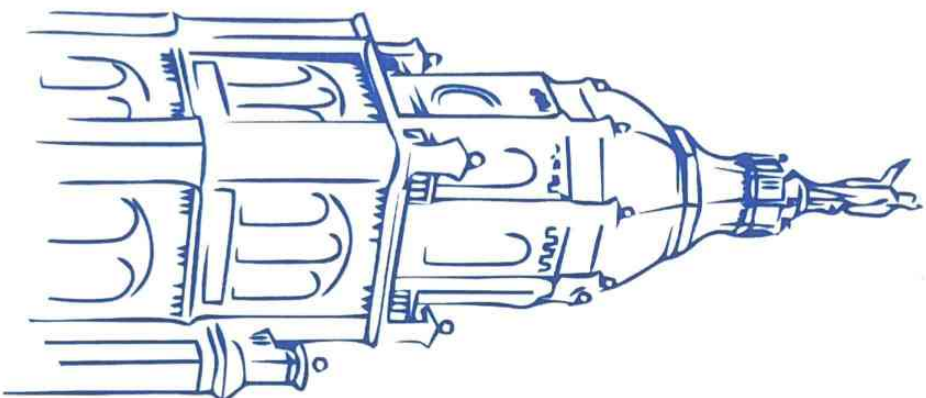

St Berchmans College
Autonomous College with Potential for Excellence Recognized by NAAC with A Grade
CHANGANASSERY, KERALA

Workshop on

Foundations of

COMPLEX ANALYSIS

&

Inauguration of

Research Centre in Mathematics

14 & 15 December 2018



Organized by

DEPARTMENT OF MATHEMATICS

In association with

INSTITUTE OF MATHEMATICS
RESEARCH AND TRAINING (IMRT)
THIRUVANANTHAPURAM

Invitation

Dear Sir/Madame,

Greetings!

We are extremely happy to inform you that Department of Mathematics, St Berchmans College, Changanacherry has become a Research Centre in Mathematics under Mahatma Gandhi University Kottayam. A formal inauguration of the same will be held at 10:00 am, Friday, 14 December 2018 in Msgr. Kallarackal Hall, followed by IMRT Workshop on Foundations of Complex Analysis. Padma Bhushan Prof M S Raghunathan (Chairman, National Centre for Mathematics) will be the chief guest of the function. Archbishop Mar Joseph Perumthottam will grace the occasion with benedictory message.

The workshop is exclusively for the First year MSc (Mathematics) students. Highly motivated final year BSc students will also be considered. We humbly request you to support the workshop by sending motivated students from your institution.

Warm regards

Rev Fr John Joseph
Principal

Dr Antony Mathews
HoD, Mathematics

Dr A R Rajan
Director, IMRT

Dr Shine C Mathew
Coordinator

About Us

St Berchmans College (Autonomous) Changanacherry, is an Arts and Science College, affiliated to the Mahatma Gandhi University, Kottayam. The College is founded in 1922 and is managed by the Catholic Archdiocese of Changanacherry. The Mathematics section at St Berchmans College came into being in 1925 with the introduction of Group I at the intermediate level with a single faculty Prof V A Mahalinga Iyer followed by Prof M T Kurian who was appointed in 1926. The Mathematics section became

Faculty

- Dr A R Rajan
Former Professor and Head
University of Kerala
- Dr K Mamila
Assistant Professor
University College Thiruvananthapuram
- Dr J P Mohandas
Assistant Professor
University College Thiruvananthapuram

Tutors

- Mr James T Kurian • Mr Jaison Jose
- Ms Anumol Thomas

Schedule

Day 1 (14 December 2018, Friday)

10.00 - 11.15	Inauguration
11.15 - 11.30	Tea
11.30 - 12.45	Fermat's Last Theorem: A Mathematical Treasure Hunt (by Prof M S Raghunathan)
12.45 - 02.00	Lunch
02.00 - 03.15	Lecture 1
03.15 - 04.15	Tutorial 1
04.15 - 04.30	Tea

Day 2 (15 December 2018, Saturday)

10.00 - 11.15	Lecture 2
11.15 - 11.30	Tea
11.30 - 12.45	Lecture 3
12.45 - 02.00	Lunch
02.00 - 03.15	Tutorial 2
03.15 - 04.15	Tutorial 3
04.15 - 04.30	Tea

a fullfledged Department in the year 1928 with the introduction of B A programme and Prof T A Satagopan MA from Madras Christian College took charge as the Head of the Department. The Post graduate course started in the year 1965. Right from the beginning the Department has striven to set high standards in teaching and learning. We have succeeded in this endeavor and over the years the Department has produced highly qualified teachers and researchers in Mathematics and Statistics, IT professionals as well as thousands of eminent personalities who perform successfully in various careers. So far the Department has, to its credit, 28 University ranks and 37 CSIR-NET holders. The Department soared to the heights of academic excellence under the efficient and effective leadership of eminent scholars. Now, in its 91st year of inception, the Department has become a Research Centre in Mathematics under Mahatma Gandhi University.

About the Workshop

Complex analysis is the area of Mathematics dealing with complex numbers and the functions of complex numbers. It deals with analytic concepts such as limits, derivatives, integrals and infinite series. The first indications that complex numbers might prove useful emerged in the 16th century from the solution of certain algebraic equations by the Italian mathematicians Girolamo Cardano and Raphael Bombelli. By the 18th century, after a lengthy and controversial history, they became fully established as sensible mathematical concepts. Many of the more advanced aspects of complex analysis are quite abstract. This Workshop will serve as a bridge course for MSc students. It is conducted as part of IMRT-Workshops: "Mathematics Enrichment Programme for Graduate Students". The Workshop contains both lectures and problem solving sessions.

The shortest path between two truths in the real domain passes through the complex domain. - J Hadamard

SD

SUMMER TRAINING PROGRAMME IN MATHEMATICS

(STPM 2019)

The Department has organized a Summer Training Programme in Mathematics from 9th May to 31st May 2019 for the MSc students (studying or qualified) in India giving equal importance to theory as well as problem solving sessions. The programme was focused on the students preparing for competitive examinations like CSIR-UGC NET, NBHM, GATE etc. A total of 63 students were participated. Among the participants, Anumol Thomas (St Berchmans College, Changanssery), Mr Sadhanandh Vishwanadh(Ramanujan Institute for Advanced Study in Mathematics) and Anjali V A(CUSAT) qualified CSIR UGC JRF/NET. Fr John J Chavara was the coordinator of the programme.



SUMMER TRAINING PROGRAMME IN MATHEMATICS

(STPM - 2019)

ORGANIZED BY

DEPARTMENT OF MATHEMATICS

09 - 31 May 2019

Invitation

Dear Sir/Madam,

The Department of Mathematics is organizing Summer Training Programme in Mathematics (STPM-2019) from 9th to 31st May 2019.[†]

The programme will be beneficial for the students preparing for competitive examinations like CSIR-UGC NET, NBHM, GATE and any MSc/PhD entrance examinations. The number of participants is limited to 40. We request you to direct motivated students to this programme.

With best regards

Rev Fr John Joseph
Principal

Dr Shine C Mathew
HoD and Convener

Rev Fr John J Chavara
Coordinator

Thrust Areas

- Abstract Algebra
- Linear Algebra
- Real Analysis
- Complex Analysis
- Differential Equations
- Linear Integral Equations
- Linear Programming
- Mathematical Statistics

[†]Sundays are holidays

Resource Persons

- Dr Didimos K V, *SH College, Thevara*
- Ms Linet Roslin Antony, *SH College, Chalakudy*
- Mr Arunkumar C S, *Research Scholar, CUSAT*
- Mr Emil Ninan Abraham, *BM College, Mavelikara*
- Mr Tibin Thomas, *SB College, Changanacherry*
- Dr Ullas Thomas, *SB College, Changanacherry*
- Dr Shine C Mathew, *SB College, Changanacherry*

Schedule

10:00 - 13:00	13:00 - 14:00	14:00 - 17:00
Lecture	Lunch Break	Tutorial

Registration

- The number of participants is limited to 40.
- The selection will be on 'First Come First Served' basis.
- Those who wish to attend the programme must register through e-mail on or before 05.05.2019.
- The selected participants will be intimated through e-mail.
- For details of fees and accommodation please contact in the following address.

Contact Us

+91 9656236761; +91 9847531272
maths@sbcollege.ac.in





MBA@SB

Registration Details Category	Registration Closes : 25.11.2018 Amount in Indian Rupees
Academician	1500
Research Scholars*	1000
Students	500

*Research scholars should produce their PhD registration proof
 Note: Registration of more than 3 participants from the same institution will be eligible for a 20% discount on the total amount payable.

Payment Details

Cash/DD/Cheque/Account Transfer

Account Details

Principal, SB College A/c No. 0340053000005010

The South Indian Bank Limited

M.C.Road, Changanacherry

IFSC: SIBL0000340

Accommodation

Accommodation will be arranged on request on or before 25.11.2018, 5.00 PM on payment basis in hotels /dormitories.

Program committee

Fr John Joseph (Principal)

Dr Stephen Mathews (Director)

Dr Siby Joseph K (Head of the Department)

Dr Babu Michael (Faculty Co-ordinator)

Ms Anney Chacko (Faculty Co-ordinator)

Dr Cris Abraham K (Faculty Co-ordinator)

Fr Sijimon G Srampical (Faculty Co-ordinator)

Contact

Ms Anney Chacko 9947095389

Fr. Sijimon Srampical 9496236279

Email : fdpbims@gmail.com

**TWO DAY
FACULTY DEVELOPMENT PROGRAMME
ON
STATISTICAL ANALYSIS FOR
RESEARCH USING SPSS AND AMOS**

Date: November 30 & December 1, 2018

Venue: Seminar Hall, MBA Department

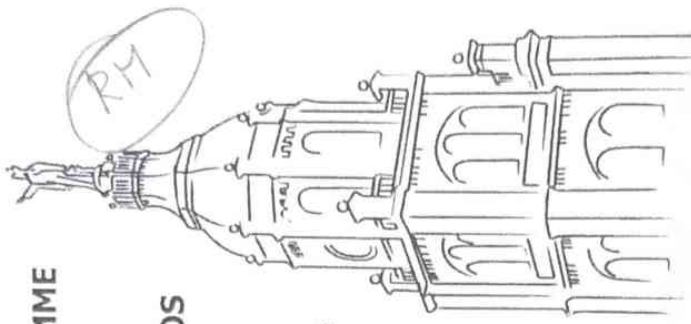

Berchmans
INSTITUTE OF MANAGEMENT STUDIES
St. Berchmans College Autonomous
Changanacherry, Kerala

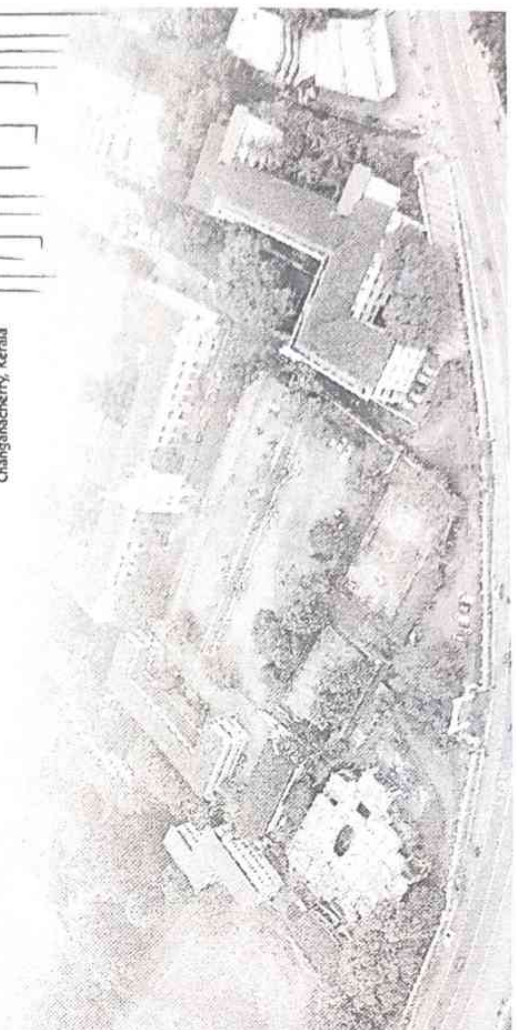

Berchmans
INSTITUTE OF MANAGEMENT STUDIES
St. Berchmans College Autonomous
Changanacherry, Kerala

St. Berchmans College

SB College Changanacherry, founded in 1922, is a renowned educational institution for higher studies in Kerala, under the Arch Diocese of Changanacherry. SB College was accorded prestigious status: "College with Potential for Excellence" by the University Grants Commission (UGC) in 2004. There are 20 Post Graduate, 16 under graduate courses, 8 Research Departments and 2 M Phil Departments.

The College was granted Academic Autonomy in June 2014 and ranked 46th Best College in India by NIRF 2018.

About BIMS

Berchmans Institute of Management Studies (BIMS) celebrates 24 years extending knowledge and changing lives. The Institute, affiliated to Mahatma Gandhi University, Kottayam, recognized by All India Council for Technical Education (AICTE), New Delhi, offers 2-year full time Master of Business Administration (MBA) Programme. BIMS witnessed the passing out of 22 batches of full-fledged MBA professionals with a high sense of ethics and commitment for the good of the society

About the FDP

The appropriate use of statistical tools in research has become the need of the day and an important requirement for social science researchers. Hence to cater to the needs of researchers and academicians, BIMS is organizing a two day FDP focusing on statistical analysis for research using SPSS and AMOS on November 30th & December 1st, 2018. The FDP begins with measurement scales and basic data entry and editing sampling design. The sessions will also engage the participants with test of influence- T Test and ANOVA. The day will also cover Factor analysis, Cluster analysis, Correlation and Regression analysis. The researchers will be guided through AMOS in the second day with focus on Confirmatory Factor Analysis, Structural Equation Modelling and concluding with Process Macros.

Resource Person for the FDP

Dr. P.S. Manjula is a Faculty member in the Department of Management Studies, University of Madras and has close to two decades of experience in Teaching and Research of Management Education. She received the Best Researcher Award for 2017 from the University of Madras for her excellent contributions in research. More recently she received Outstanding Woman in Management Award from the VIWA International Foundation in 2018 for her contribution in Research of Organisational Behaviour. She has published more than 40 papers in journals of repute including UGC listed and Scopus indexed journals. She is also on the Editorial Review Board of several journals. She is a resource person for Orientation and Refresher Programmes conducted by the UGC- Human Resource Centre, University of Madras. She was key resource person for over 55 Workshops.



PROGRAMME SCHEDULE

DAY 1 : 30th November 2018

9.00 - 9.15 am	Inauguration
9.15 - 10.30 am	Measurement Scales
10.30 - 10.45 am	Break
10.45 - 1.00 pm	Overview of SPSS Sampling Design
1.00 - 2.00 pm	Lunch Break
2.00 - 3.30 pm	Non- Parametric Tests of Influence- T test and ANOVA Factor Analysis and Cluster Analysis
3.30 - 3.45 pm	Break
3.45 - 5.00 pm	Correlation and Regression Analysis

DAY 2 : 1st December 2018

9.00 - 10.30 am	Introduction to AMOS
10.30 - 10.45 am	Break for Tea
10.45 - 1.00 pm	Validity and Reliability Confirmatory Factor Analysis Average Variance Extracted (AVE) Construct Reliability (CR) Cronbach's Alpha Convergent Validity Discriminant Validity
1.00 - 2.00 pm	Lunch Break
2.00 - 3.30 pm	Structural Equation Modeling Model Fit Summary Goodness of Fit Index (GFI) Adjusted Goodness of Fit Index (AGFI) Normated Fit Index (NFI) Comparative Fit Index (CFI) RMR RMSEA
3.30 - 3.45 pm	Break
3.45 - 4.00 pm	Process Macros - An Introduction
4.00 - 4.15 pm	Valedictory
4.15 - 4.30 pm	Certificate Distribution

Dr C C Thomas is an authority on Shakespeare production and research. He directed four Shakespeare plays. His unfathomable knowledge in Shakespeare has remained an inspiration for generations of students. There are very few scholars such as Dr C C Thomas to unfold Shakespearean profundity. He has also authored several books and published a number of research papers and articles.

Dr Gigy Joseph is an eminent and a resourceful teacher. He is a great scholar, director of Shakespeare plays, a specialist in fiction, poetry, and cinema. He directed Shakespeare's *Macbeth* and *The Tempest*. He has also authored several books and published a number of research articles.

re
pp

09 and 10 Feb 2018
Venue: Purackal





Prof George Thomas (1964-2015) was an illustrious teacher and a charismatic personality. He served as the member of faculty in the Department of English, St Berchmans College from 1989 to 2015. As a teacher he specialised in Journalism and Media Studies and was instrumental in establishing and giving shape to the Journalism based Vocational English Graduation programme in St Berchmans College. A large number of students have been inspired and initiated into the media world by this excellent teacher and at present they adorn the leading media space in Kerala. As a public figure he was always an extra-mile person and his empathy for the needy had no limits. The band of friends around him throughout was the proof of his abiding spirit of camaraderie. His colleagues remember him as a go-to man who always brought consolation and encouragement in times of crisis and sorrow.

St Berchmans College
AUTONOMOUS *Creating and Sustaining the Foundation* Established by M.M.C. Co. of India

**Prof George Thomas
 Memorial**

**Media
 Seminar**

19 December 2018
 Venue: Cardinal Padiyara Hall

SD

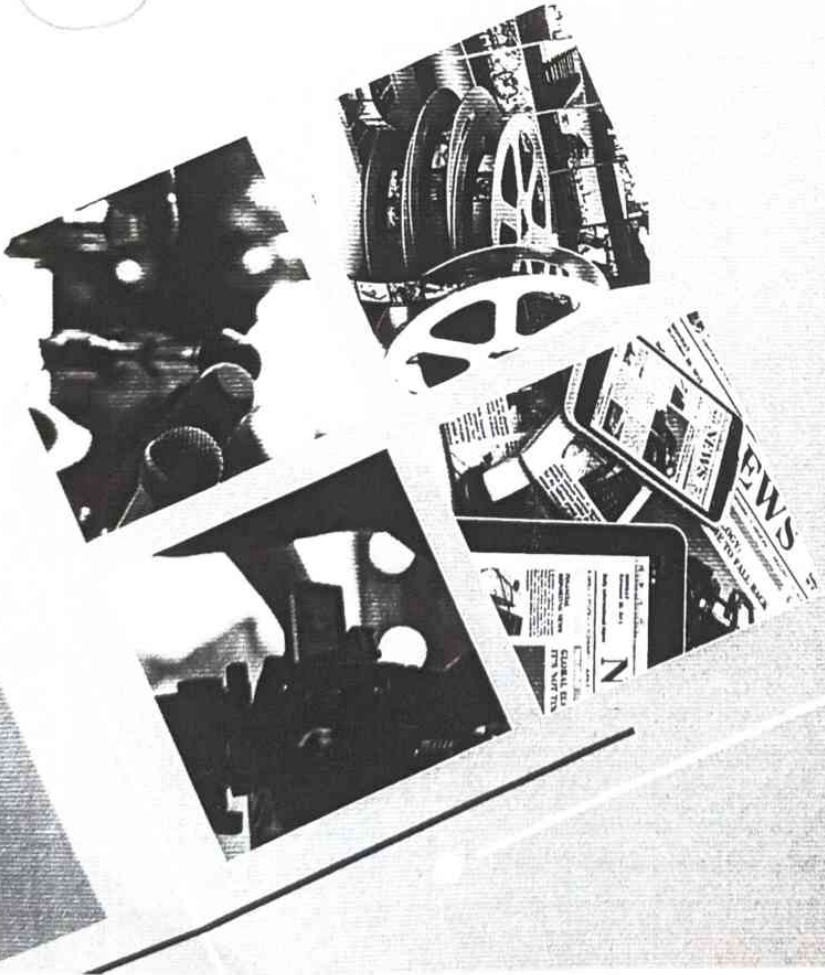

**One Day
Nation Seminar
Cashless
Economy In
India
15/09/2018
Dr Sunil Mani
Director, CDS
Trivandrum**

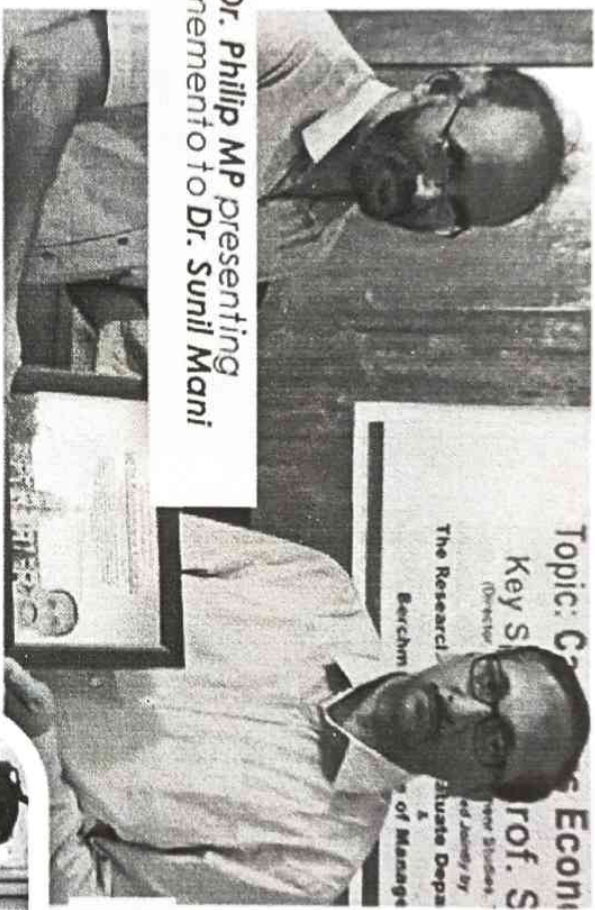

Dr. Phillip MP presenting memento to Dr. Sunil Mani



Students interacting in the seminar



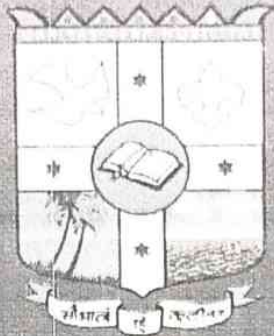

TOPIC:
Android OS

**ST. BERCHMANS
COLLEGE**

BY,

BY

**SYNTAX
TECHNOLGY**

**DEPARTMENT OF
COMPUTER SCIENCE**

ERNAKULAM

ON 03/9/2018

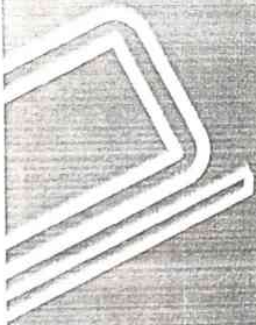



Sadanand Menon is a well known and highly respected writer, journalist, arts editor, cultural critic, photographer and performance expert. He is a regular speaker at seminars and conferences on politics, literature, ecology and arts. He is a visiting faculty at the Asian College of Journalism and the Indian Institute of Technology, Chennai. He writes for many publications including *The Hindu* and *India Today*.

Golden Jubilee Lecture Series

One of the highlights of our Golden Jubilee Celebrations is a series of lectures by eminent scholars and intellectuals. The first lecture was given by **Professor Pramod K Nayar** (Hyderabad University) on 29 January 2018 on *Ecoprecarity: The New Culture for Reading Literature and Culture*. Over the next many months, we intend to bring several eminent scholars and intellectuals to the campus.

Department of English
St Berchmans College
Changanassery

Golden
Jubilee
Lecture
Series



Art, Literature and Criticism
by

Sadanand Menon

11 am
Friday, 23 February 2018
Cardinal Padiyara Hall

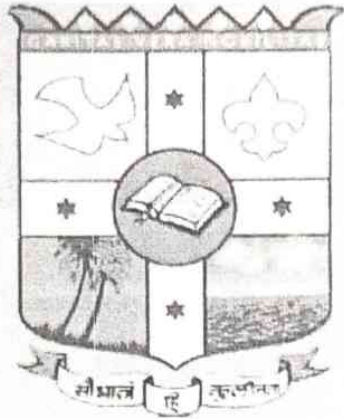

ST BERCHMANS COLLEGE

TALK ON

RECENT TRENDS IN IT

BY

ABBY THOMAS

ASST.MANAGER/MARKETING

ZION IT COMPANY

JOS JUNCTION,ERNAKULAM

ON 30/8/18

BY

DEPARTMENT OF COMPUTER SCIENCE

KNOW TAX...PAY TAX

Title- Awareness campaign on income tax rules and regulations

In collaboration with – Income Tx Department

19 February 2019

SD



COMMERCE DAY – ASSOCIATION VALEDICTORY FUNCTION –PASSING OUT CEREMONY

